

General information

PWS820260415

The tension and compression load cell 60050 (also known as traction or S-type load cell) has been designed for the industrial fiscal weighing of small tanks and hoppers. The traction load cell 60050 has excellent characteristics of linearity and precision and an excellent resistance to overloads of more than 300%. The 60050 S-type cell is made of stainless steel and it is waterproofed to be used in severe environmental conditions.



Suggested related products

A highly performing weighing system must be accurate, perfectly calibrated and well maintained. In order to improve the load cell performance and to optimize its functioning, you may need the following products:

Weight Transmitter [UWT 6008](#)

Weight Transmitter [DAT 1400](#)

Tester 1008 [TESTER 1008](#)

Junction Box [CGS4-C](#)

Universal load cell [CS20](#)

Universal load cell [CS30](#)

All indicated data may be changed without notice.
All the measures indicated are expressed in millimeters (mm).

Technical specifications

PWS820260415

Rated load (RL):	50, 100, 250, 500, 1000, 2500, 5000, 10000 Kg
Combined error:	< ± 0.02 % RO
Repeatability:	< ± 0.01 % RO
Creep (30 minutes):	± 0.017 % RL
Safe overload:	150 % RL
Ultimate overload:	300 % RL
Material:	Stainless steel
Degree of protection:	IP67
Accuracy class:	3000 OIML (250 ÷ 2500 kg)
Deflection:	0.3 ÷ 0.6 mm
Compensated Temperature:	-10 ÷ +40°C
Temperature range:	-18 ÷ +65°C
Temperature effect on zero balance:	< ± 0.0010 % RL/°F
Temperature effect on output:	< ± 0.0007 % RL/°F
Rated output RO:	3 mV/V
Zero balance:	< ± 1 % RO
Insulation resistance:	> 1000 MOhm
Input resistance:	343 ÷ 450 Ohm
Output resistance:	349 ÷ 355 Ohm
Recommended input:	5 ÷ 15 Vdc/ac

All indicated data may be changed without notice.
All the measures indicated are expressed in millimeters (mm).

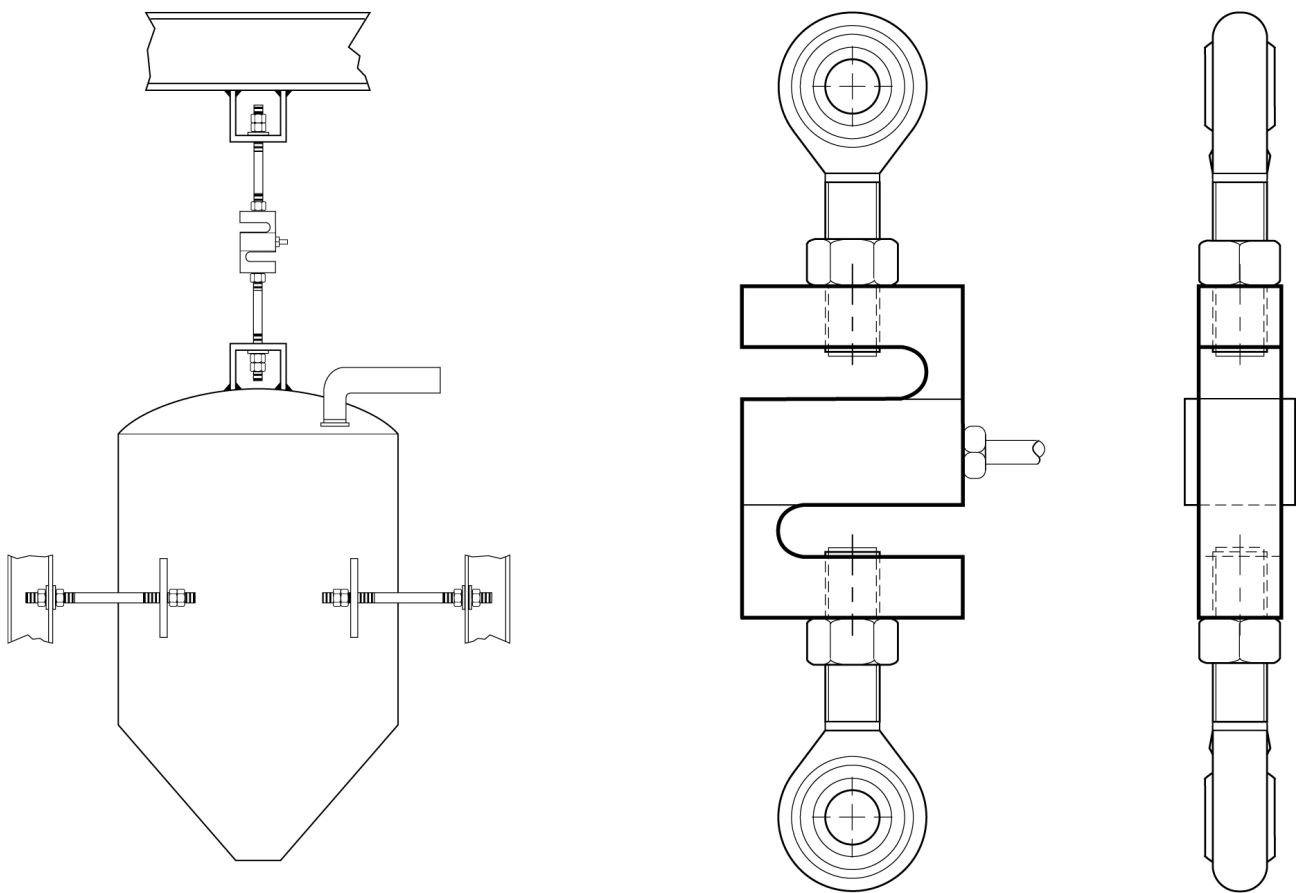

All indicated data may be changed without notice.
 All the measures indicated are expressed in millimeters (mm).

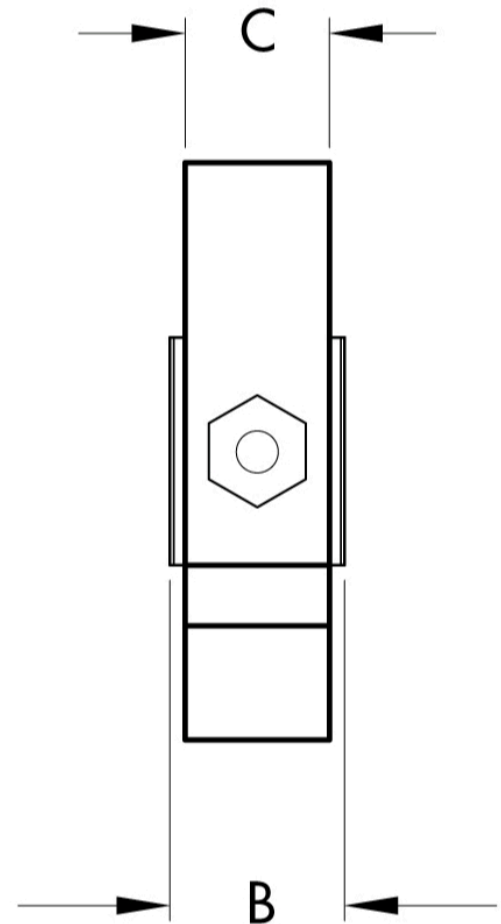
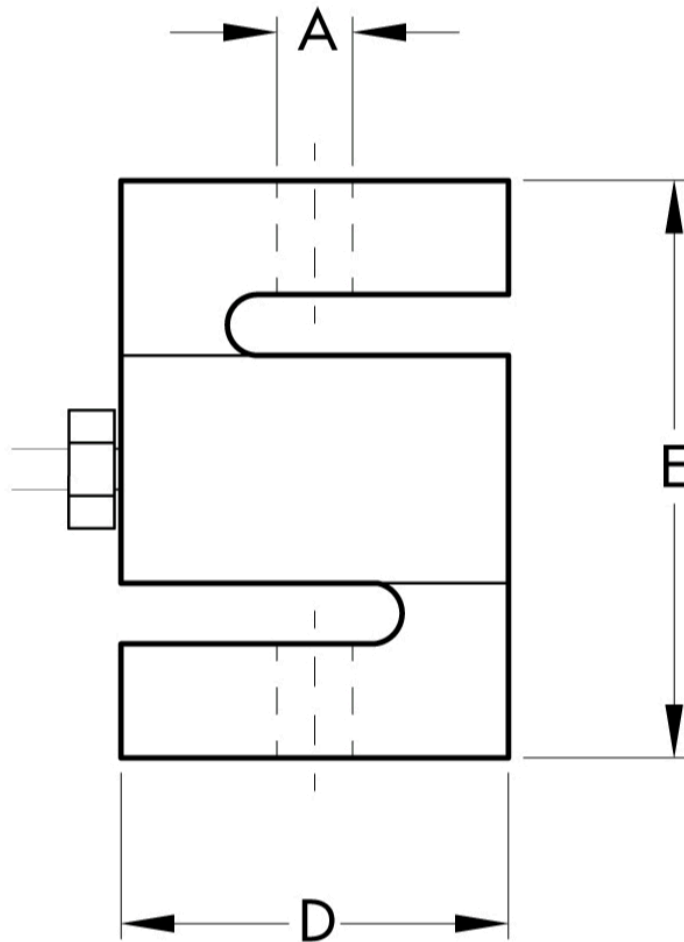
Electrical Connection

+Excitation	Red
-Excitation	Black
+Signal	Green
-Signal	White
Shield	Cable shield

CAPACITY	A	B	C	D	E
50-100 kg	M8x1.25-6H	16.5	12.7	50.8	63.5
250 kg - 1 t	M12x1.75-6H	25.4	19.1	50.8	76
2.5 t	M20x1.5-6H	31.8	25.4	76.2	108
5 t	M20x1.5-6H	31.8	25.4	88.9	120.7
10 t	M30x2.0-6H	57.2	50.8	127	177.8

All indicated data may be changed without notice.
 All the measures indicated are expressed in millimeters (mm).